

WHICH ATTACHMENT FOR THE JOB?

There is a wide selection of useful accessories, which opens an infinite number of possibilities for jobs in the kitchen. You yourself can best decide which of these accessories are especially suited for your needs.

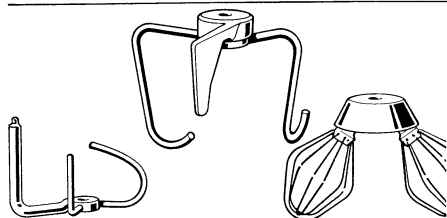

Mixing and Kneading Set for stirring and kneading light or heavy dough, from the lightest cookie dough to the heaviest yeast, gingerbread or noodle dough (wire whips for standard model only).

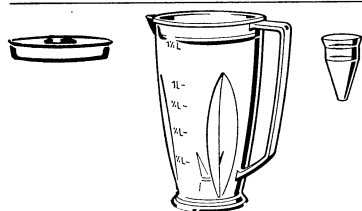

Blender for mixing drinks, mayonnaise, eggnog, small quantities of pancake mixture, for chopping vegetables (for diet and baby food), herbs and nuts.

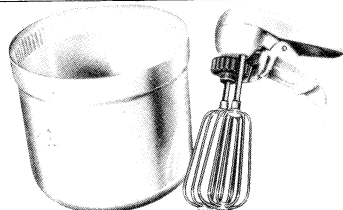

Beater and Bowl (for deluxe model) for beating and stirring all light ingredients, e.g., egg whites (up to 6 at a time), whipping cream (up to 1 pint), very light batter.

Order No. 0 712 004 001

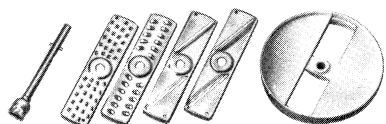

Slicer and Shredder — drive disc with 4 slicing and shredding inserts (for deluxe model with shaft) —
Fine slicing disc: for cutting cucumbers, radishes, cooked beets, potatoes (for potato chips), raw cabbage, turnips, etc.
Coarse slicing disc: for cutting raw and cooked potatoes for salads and hashed browns, vegetables, all sorts of cabbage, carrots, apples, onions, etc.
Fine shredding disc: for grating raw or cooked potatoes for soups, potato pancakes or dumplings; chocolate, Swiss cheese, etc.
Coarse shredding disc: for grating small carrots, radishes, celery, cabbage, etc. for vegetarian salads.
Order No. 0 712 008 102
for deluxe model 0 712 008 103

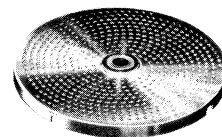

Potatoe Shredding Disc with cross-type drive for grating potatoes for dumplings, etc.
Order No. 0 712 010 100

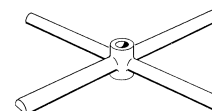

Centrifugal Juicer for obtaining fresh juice from fruit and vegetables for daily use.
Order No. 0 712 500 007

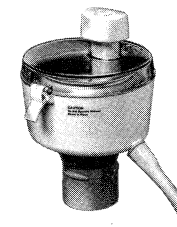

Meat Grinder for grinding raw and cooked meat, vegetables (especially spinach and cabbage), bacon, liver, etc.
Order No. 0 712 012 010

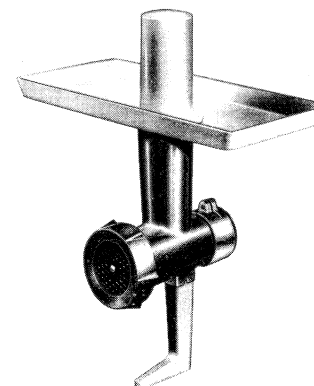

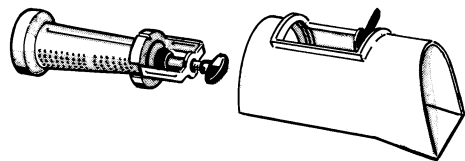

Attachments for Meat Grinder

Berry press for obtaining juice from berries, for making tomato puree, jellies and seedless preserves.
Order No. 0 712 013 006

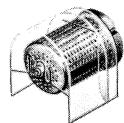

Grating attachment for grating dry nuts, figs, dates, chocolate, hard bread, cheese, raw and cooked potatoes into an even consistency.
Order No. 0 712 014 001



Pastry press for making cookies.
Order No. 0 712 016 001

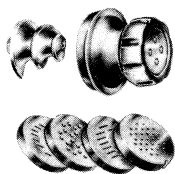

Noodle attachment for making noodles, macaroni, thin noodles for soups, and broad noodles.
Order No. 0 712 015 002



Sausage filler for stuffing different kinds of sausages, for shaping croquettes and dumplings.
Order No. 0 712 017 002 1/2"
0 712 017 001 3/4"
0 712 017 004 1 1/4"

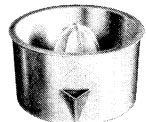

Citrus Squeezer for squeezing lemons, oranges and grapefruit.
Order No. 0 712 007 002

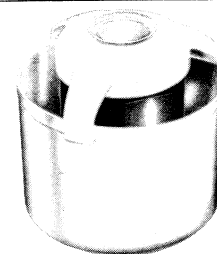

Ice-cream Freezer for preparing the finest ice creams.
Order No. 0 712 006 001

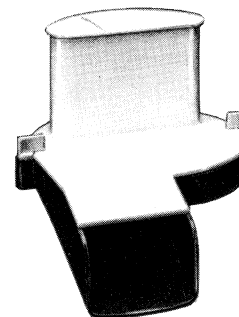

Extrusion Shredder with 1 double usage slicing and 2 shredding discs for slicing and shredding large quantities of fruit and vegetables, raw and boiled potatoes.
Order No. 0 712 020 004

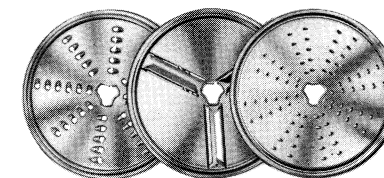

Peeling potatoes, carrots, beets, rutabagas, and Jerusalem artichokes is easy with the Potato Peeler.
Order No. 0 712 003 003

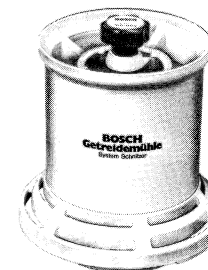

This grain mill is another up-to-date attachment to add to our comprehensive range for the Bosch Kitchen machine.
Order No. 0 712 002 100.